

Container Shelter
Model 20'x20'
W6.0xL6.0xH2.0m
(1.5m arch space)
Assembly Instructions

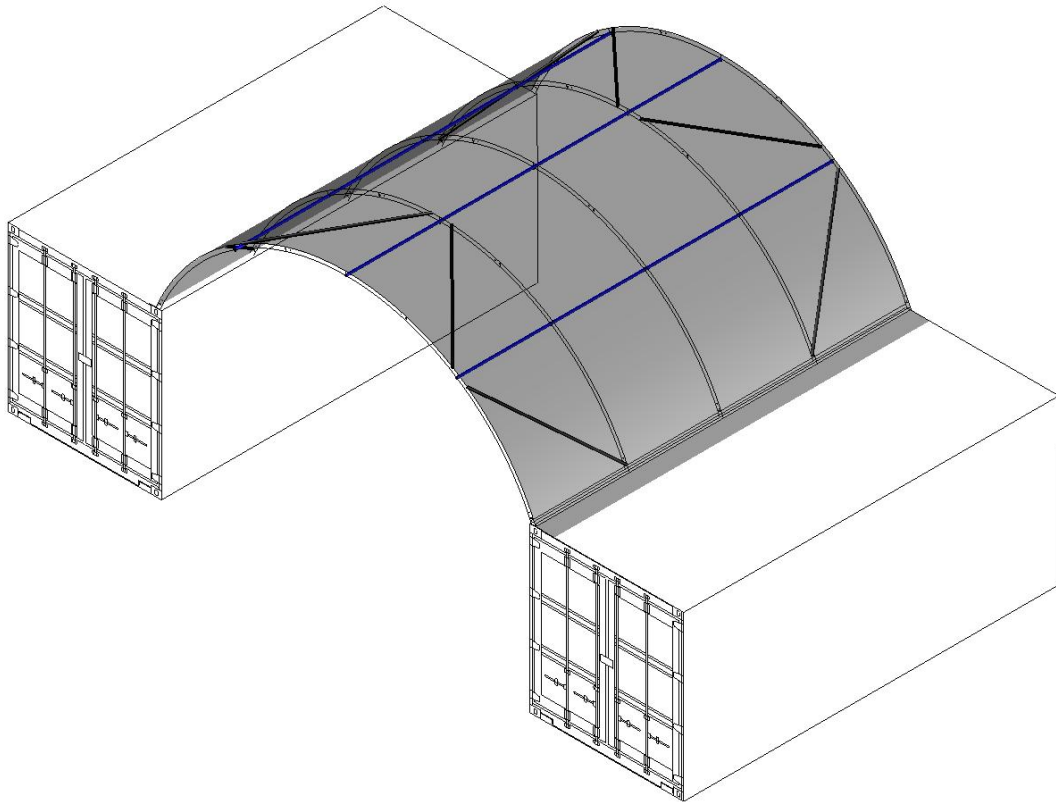

RECOMMENDED TOOLS

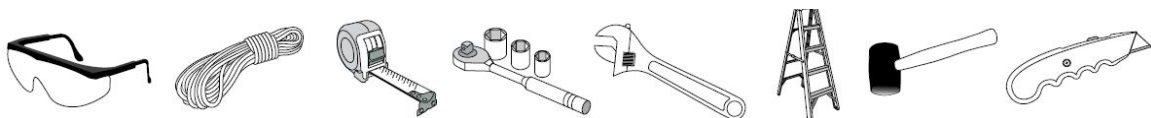

RECOMMENDED TOOLS

Equipment List

<p>Speed Wrench 22#.23#.24#</p>	
<p>Hammer (30lb)</p>	
<p>Rope (12#)</p>	
<p>Long Tape (50m)</p>	
<p>Hammer Drill*1</p>	
<p>Lifter*2</p>	
<p>Crane*1</p>	
<p>Forklift*1</p>	
<p>Protective equipment</p>	



YOU MUST READ THIS DOCUMENT BEFORE YOU BEGIN TO ASSEMBLE THE SHELTER.

Thank you for purchasing our shelter. When properly assembled and maintained, this product will provide years of reliable service. These instructions include helpful hints and important information needed to safely assemble and properly maintain the shelter. Please read these instructions **before** you begin.

If you have any questions during the assembly, please contact local dealer for assistance.

SAFETY PRECAUTIONS

- . Wear eye protection.
- . Wear head protection
- . Wear gloves when handling metal tubes
- . Use a portable GFCI (Ground Fault Circuit Interrupter) when working with power tools and cords.
- . Do not climb on the shelter or framing during or after construction.
- . Do not occupy the shelter during high winds, tornadoes, or hurricanes.
- . Provide adequate ventilation if the structure is enclosed.
- . Do not store hazardous materials in the shelter.
- . Provide proper ingress and egress to prevent entrapment.

ANCHORING INSTRUCTIONS

Prior to assembling this shelter, please read the **MUST READ** document included with the shipment.

⚠ WARNING: The anchor assembly is an integral part of the shelter construction. Improper anchoring may cause shelter instability and failure of the structure. Failing to anchor the shelter properly **will void the manufacturer's warranty** and may cause serious injury and damage.

LOCATION

Choosing the proper location is an important step before you begin to assemble the structure.

The following suggestions and precautions will help you determine whether your selected location is the best location.

- . Never erect the structure under power lines.
- . Identify whether underground cables and pipes are present **before** preparing the site or anchoring the structure.
- . Location should be away from structures that could cause snow to drift on or around the building
- . Do not position the shelter where large loads such as snow and ice, large tree branches, or other overhead obstacles could fall.











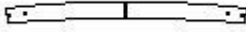

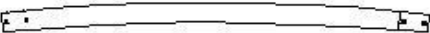
SITE





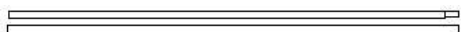
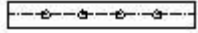

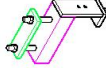
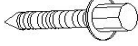
After choosing a location, proper preparation of the site is essential. The following site characteristics will help ensure the integrity of the structure.

- . The support structure must be level to properly and safely erect and anchor the frame.
- . Drainage: Water draining off the structure and from areas surrounding the site should drain away from the site to prevent damage to the site, the structure, and contents of the structure.

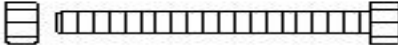
⚠ WARNING: The individuals assembling this structure are responsible for designing and furnishing all temporary bracing, shoring and support needed during the assembly process. For safety reasons, those who are not familiar with recognized construction methods and techniques **must seek the help of a qualified contractor.**

Parts List of Container Shelter L6xW6xH2m

No.	Description	Drawings	Q'ty
1	Roof Bent Joist		5
2	Middle Bent Joist		10
3	Shoulder Bent Joist		10
4	Purlins		12
5	Bracing Tube		8
6	Square Tube Rails-1		2
6A	Square Tube Rails-1A		2
7	Square Tube Rails-2		2
8	Tension Tube (2+1pcs/group)		2
9	Connection Plate for Rails		12
10	Angle Steel Base		20
10A	Corner Clamps		4
10B	Base Rail Clamps		10
10B	Self - Screw M8*40mm		24
11	Φ60 clip		16
12	M8*70 bolt for arches		60+6

13	M10x80 carriage bolt for purlins		15+2
14	M12x120 bolt for square tube rails		24
15	32 plug		4
16	(38*900mm) strap for tension roof cover		10
17	75CM nylon tie		30
18	4# ropes		40
19	1.5inch Winch		4
20	Roof Cover		1

CONTAINERS LOCATION:

The distance between 2 x 20ft GP container is 19'2''(5854mm), make sure they are level and square to each other.

The diagonal distance from corner point to opposite corner point is 27'9'' (8452mm)

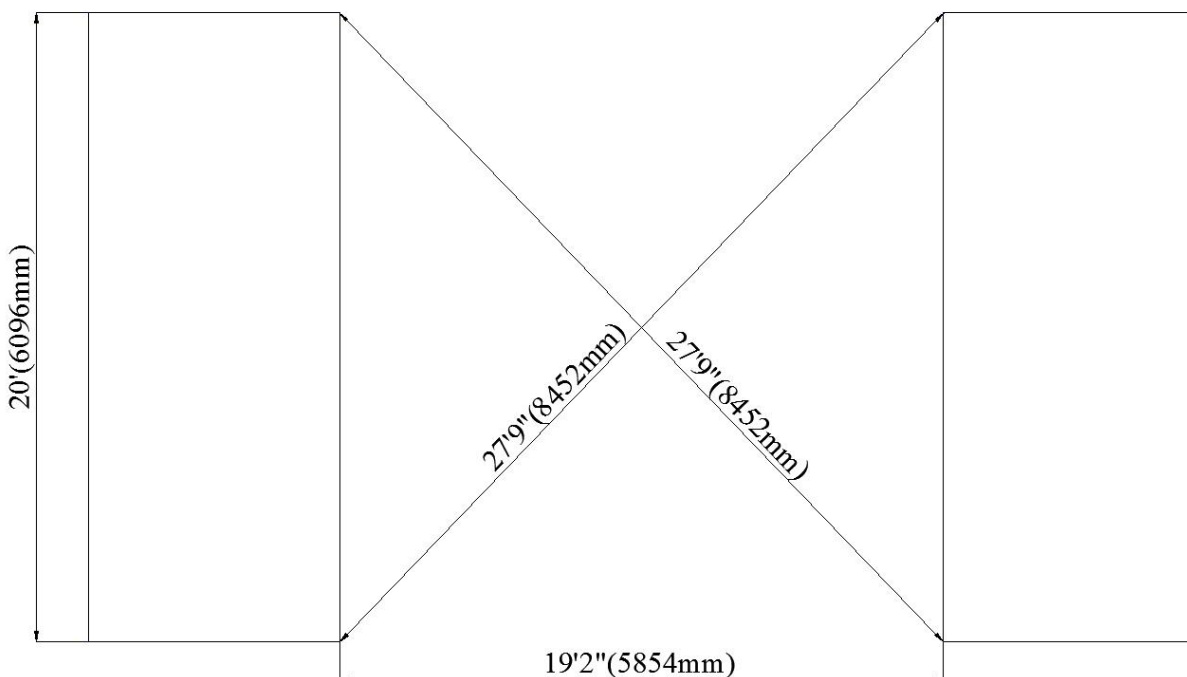

Framework Installation

Note: Please do firmly fix the containers on the ground before installation of the shelter.

1. Connect square tube rails (No.6, No.6A and No.7) by Connection Plate No.9 with Bolt No.14. Two ends of square tube rails is fixed to the corner of containers with clamps No.10 A

Two kinds of methods to fix base rails as the below drawings for option:

Option A: Using base rail clamps No.10B to fix the square tube rails to the top of container without any welding works as the below figure.

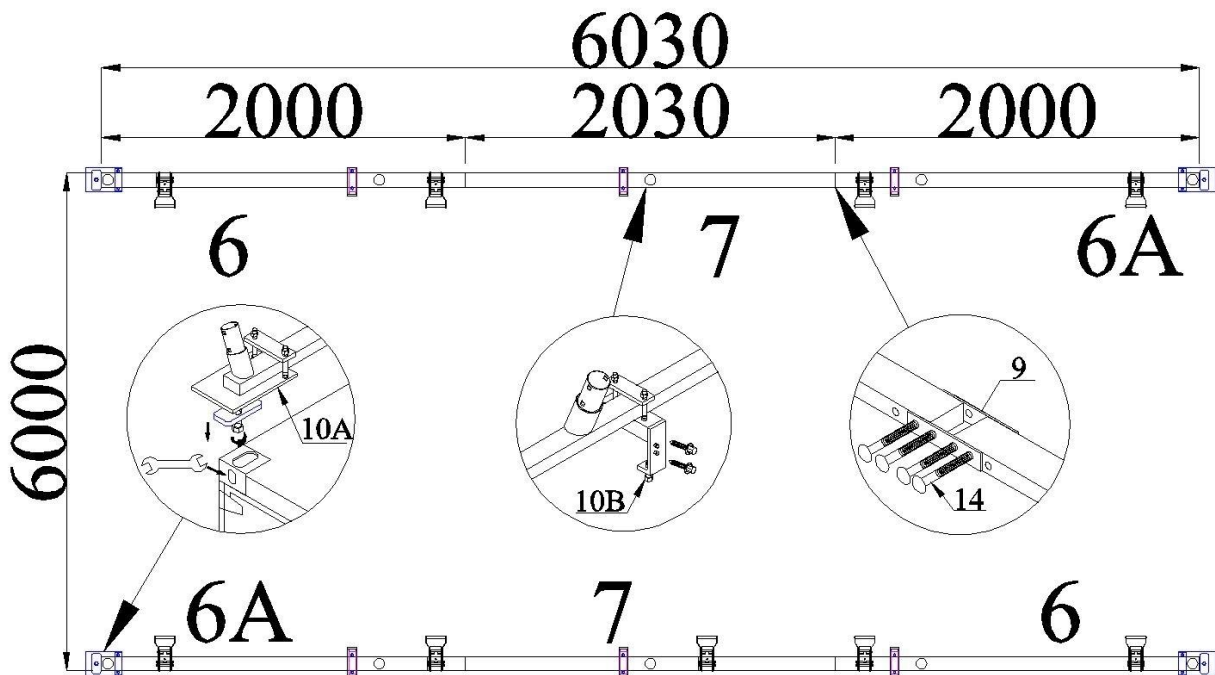

Option B: Welding angle seat to fix the square tube rails to the top of container.

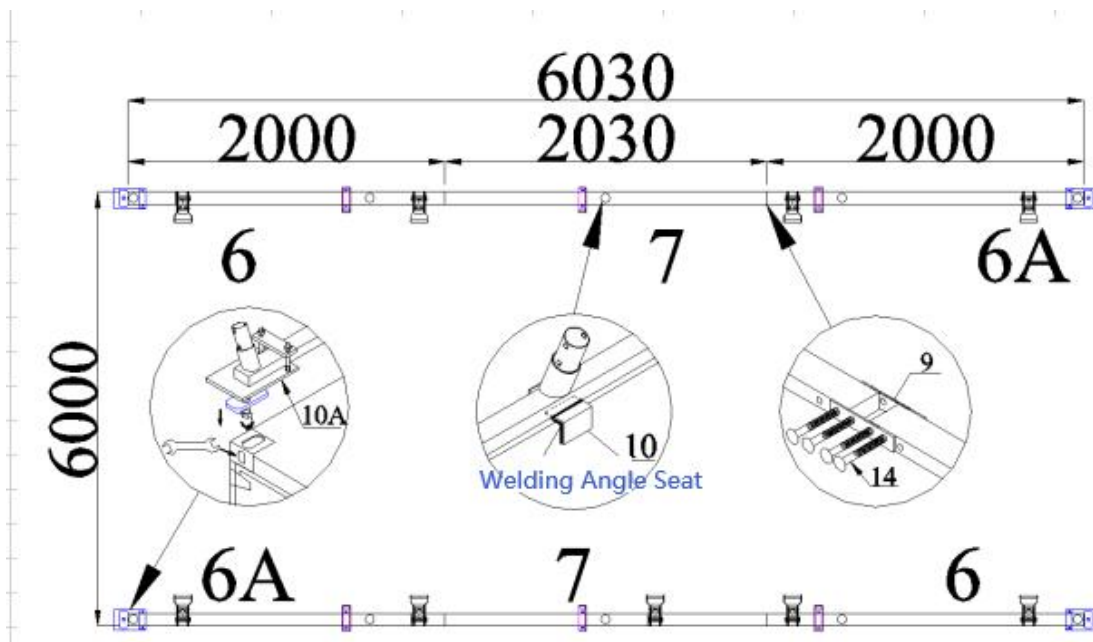
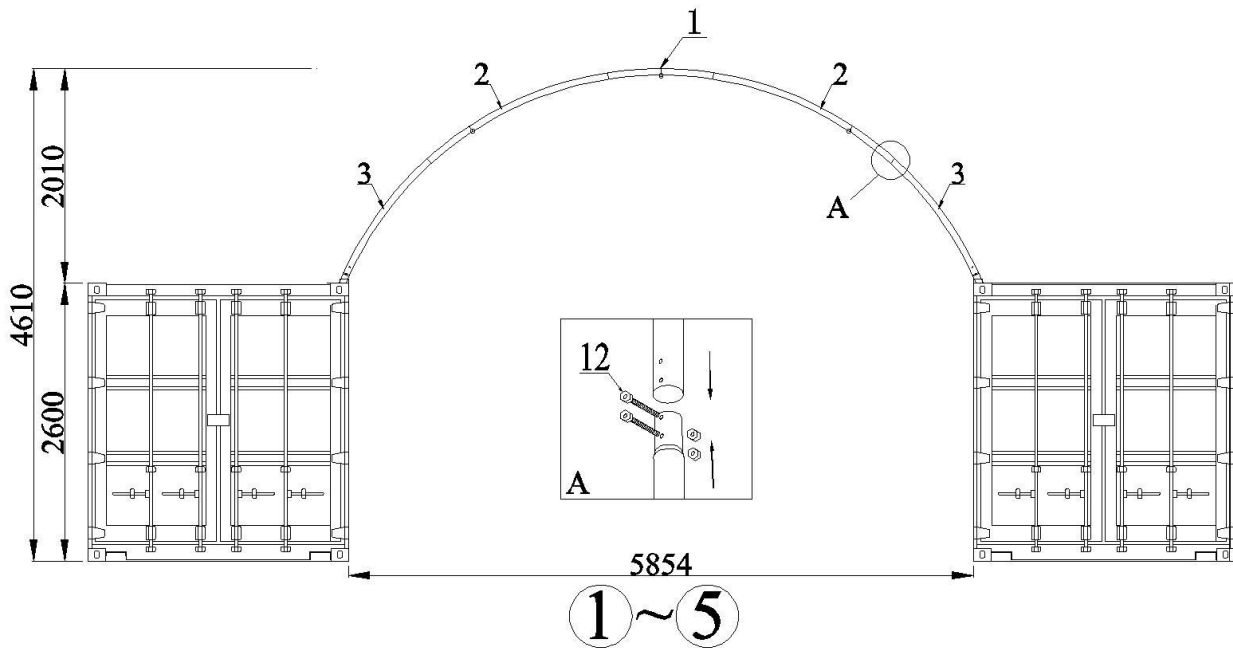

Figure 1

2. Connect the Bent Joist (No.1, 2, 3) by bolt M8x70 No.12 to be one arch.
3. Put one end of the arch into the mount rail spigot and fasten it by bolt M8x70 (No.12), then put the other end to opposite rails.

Arch No.1



Purlins and Bracing Tubes Installation

3. When 2 arches are in place, connect purlins (No.4) between them by carriage bolt M10x80 (No.13). Please note the direction of the bolt, do not leave the shaft outside where the fabric will rest. By this way, one arch and purlins between it in turn, frames are installed.
4. Install bracing tube (No.5) by Clip (No.11).

Note: Before install the arch, please install the clip firstly.

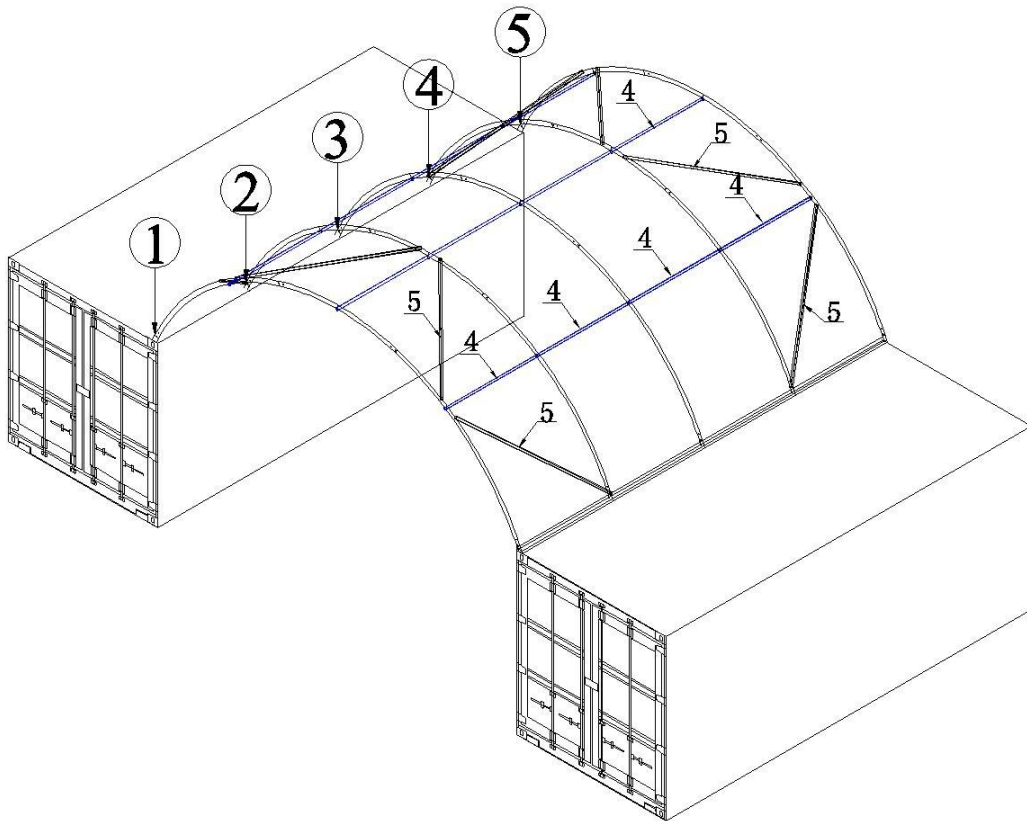
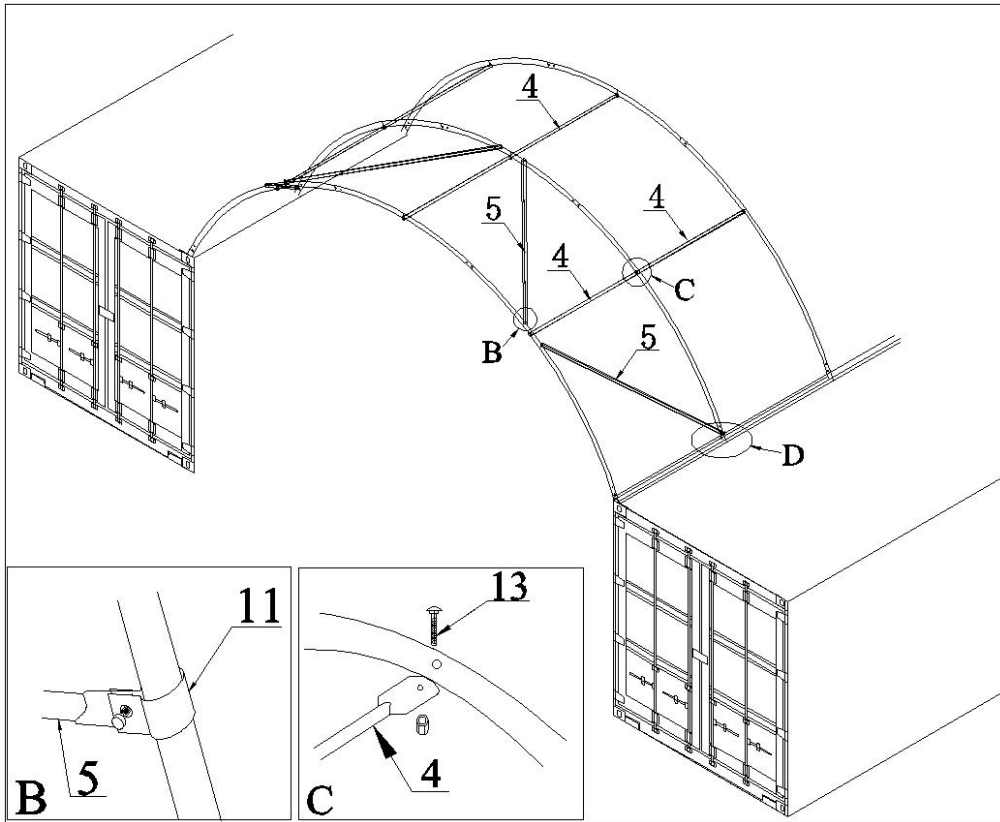



Cover Installation

1. Put the cover **EVENLY, CAREFULLY AND SLOWLY** on the frame. Insert the Tension Tubes (No.8) into the cover pipe pockets and loosely secure the strap (No.16) in the winch on square tube rails. **DO NOT TIGHTEN**. Adjust the cover so that it is square and evenly centered on the frame.

Note: The end flaps must overhang evenly at both ends.

2. Firstly use nylon tie (No.17) to fix the two ends of roof cover to end arches at intervals. Then use Rope (No.18) to tighten roof cover to end arches. The rope should be cut as your requirements when using. When the cover is tidy and ready, drive the winch tie down forth and back and then roof cover is tightened.

3. Pull the band inside the roof cover (four corners) by Winch (No.19). The winches No.19 should be welded or fastened with self-screws to container.

Note: **DO NOT LEAVE COVER UNATTACHED UNDER ANY CIRCUMSTANCES** until the final assembly and tightening has been completed.

The process is quite easy. But some tightening adjustments will be necessary to produce a flat, tight roof cover.

Roof Cover

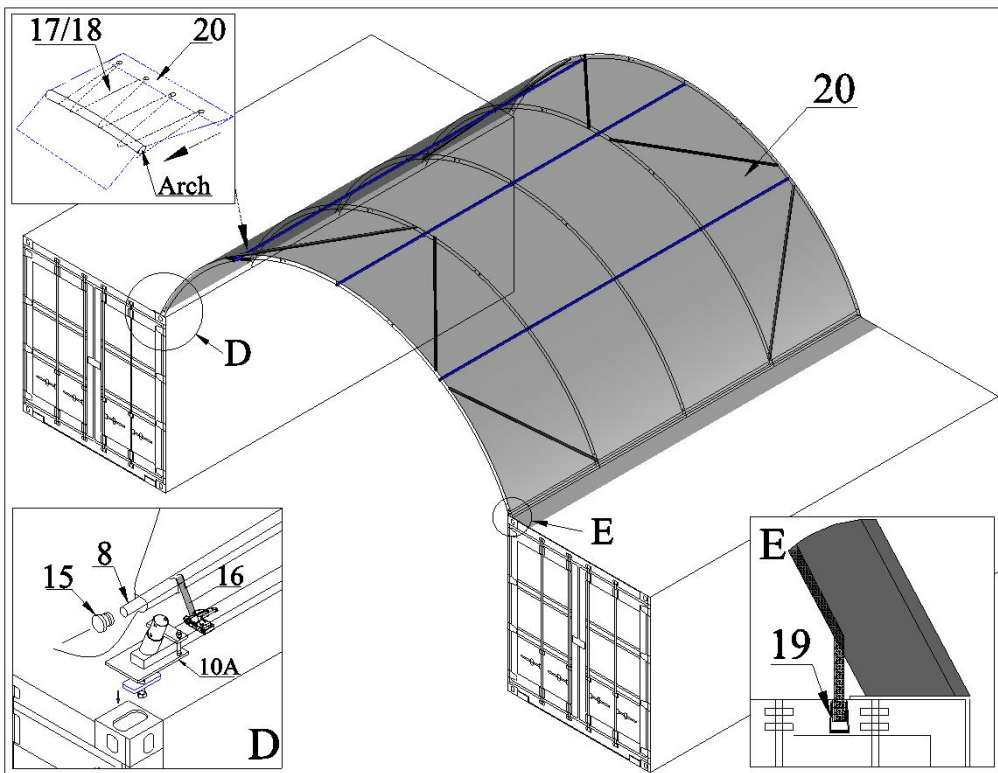

The installation is completed!